



CRAVINORD

ACCESSORI TELONI

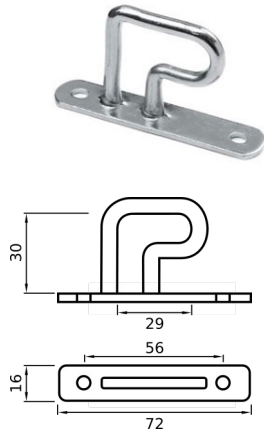

www.cravinord.com

CAVALLOTTI, ANELLI E GANCI
CAVALLOTTO 2 FORI PIPA

CODICE	Versione
CN022.CA03010330	ZINCATA

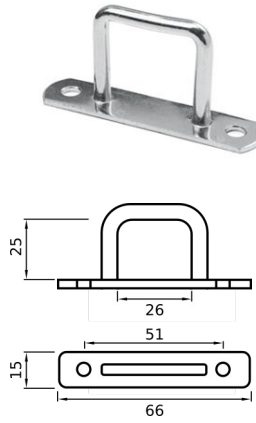
CAVALLOTTO 2 FORI

CODICE	Versione
CN022.CA03030125	ZINCATA

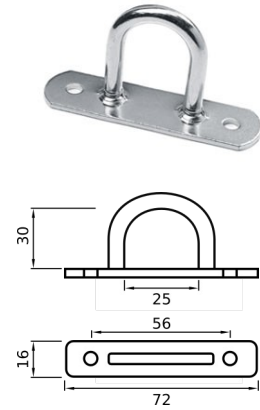
CAVALLOTTO 2 FORI TONDO

CODICE	Versione
CN022.CA03030230	ZINCATA

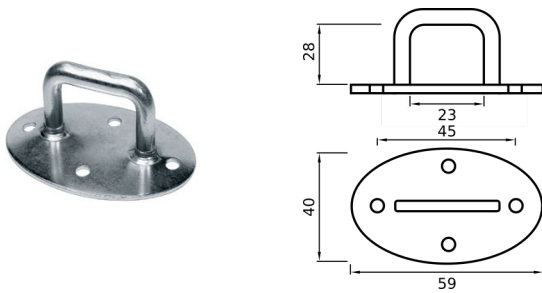
CAVALLOTTO 4 FORI

CODICE	Versione
CN022.CA03040128	ZINCATA

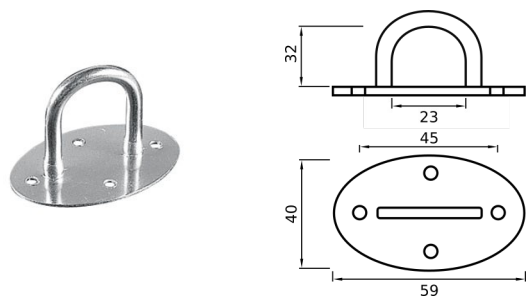
CAVALLOTTO 4 FORI TONDO

CODICE	Versione
CN022.CA03040232	ZINCATA

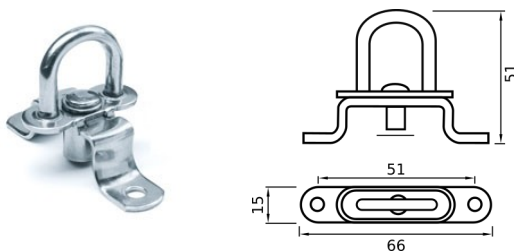

CAVALLOTTO A MOLLA SNODATO

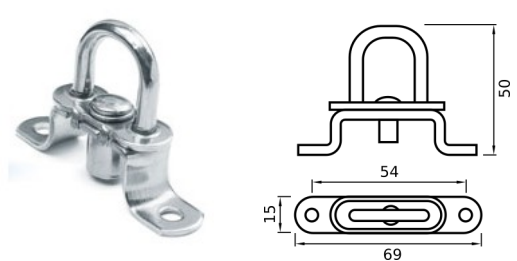
CODICE	Versione
CN022.CA03050220	ZINCATA

CAVALLOTTO A MOLLA FISSO

CODICE	Versione
CN022.CA03050120	ZINCATA

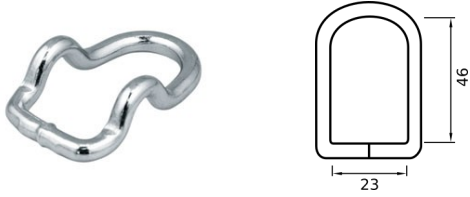
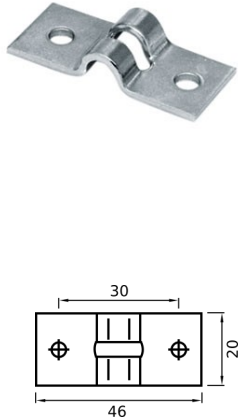
CAVALLOTTI, ANELLI E GANCI

ANELLO A PERA SAGOMATO		PIASTRA PER ANELLO A PERA	
			
CODICE	Versione	CODICE	Versione
CN022.CA03072346	ZINCATA	CN022.PI03079099	ZINCATA
ANELLO A PERA		ANELLO A PERA	
			
CODICE	Versione	CODICE	Versione
CN022.CA03072329	ZINCATA	CN022.CA03072343	ZINCATA

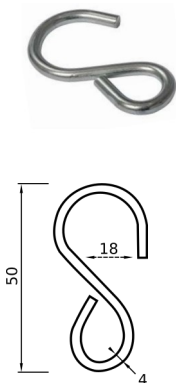
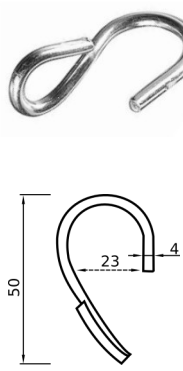
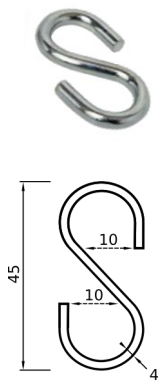
GANCIO S CHIUSO		GANCIO S GIRATO CHIUSO		GANCIO S APERTO	
					
CODICE	Versione	CODICE	Versione	CODICE	Versione
CN022.GA070102FZ	ZINCATA	CN022.GA070104FZ	ZINCATA	CN022.GA070101FZ	ZINCATA



CAVALLOTTI, ANELLI E GANCI

GANCIO SPONDA A BECCO

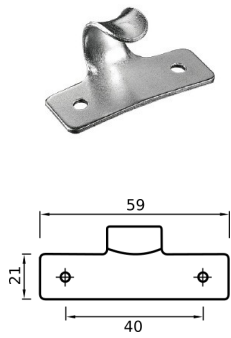

CODICE	Versione
CN022.GA070303FZ	ZINCATA

GANCIO ZIG-ZAG APERTO

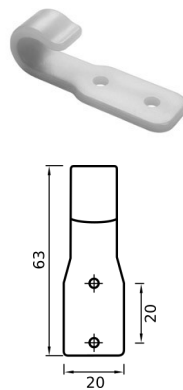

CODICE	Versione
CN022.GA070501AC	NYLON

GANCIO ZIG-ZAG CHIUSO

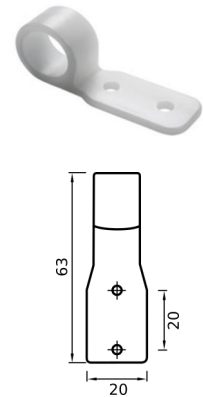

CODICE	Versione
CN022.GA070502AC	NYLON

GANCIO SPONDA

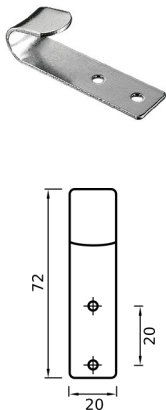

CODICE	Versione
CN022.GA070302FZ	ZINCATA

GANCIO COBRA GRANDE

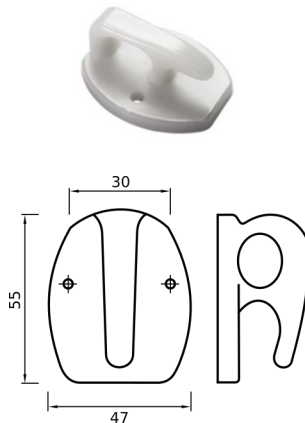

CODICE	Versione
CN022.GA070703GB	NYLON

GANCIO TENDITELO C/SICURA ROSSO

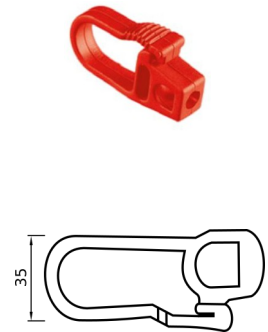

CODICE	Versione
CN022.GA07096506	POLIPROPILENE

GANCIO SPONDA S LARGO

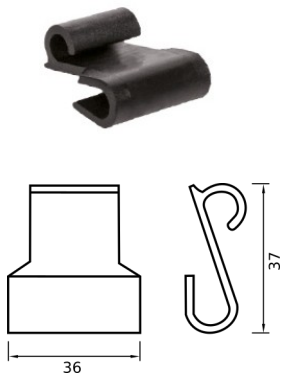

CODICE	Versione
CN022.GA070314NY	NYLON NERO

GANCIO CESTELLO DIAMETRO 8



CODICE	Versione
CN022.GA07090801	ZINCATA

RIBATTINO PER TELO M/F



CODICE	Ø
CN022.RIMF600000	6
CN022.RIMF800000	8



CORDA, CAVI E ACCESSORI

CORDA ELASTICA Ø 8



FASCETTA PER CORDA ELASTICA



CODICE	Versione	Rotolo	CODICE	L	H
CN022.CEB8000000	BLU	200 Mt.	CN022.FA05080101	25	10
CN022.CEG8000000	GRIGIA	200 Mt.	CN022.FA05080102	12	10
CN022.CEN8000000	NERA	200 Mt.			
CN022.CER8000000	ROSSA	200 Mt.			
CN022.CEV8000000	VERDE	200 Mt.			
CN022.CEY8000000	GIALLA	200 Mt.			

CAVO TIR ACCIAIO



CAPOCORDA







CODICE	Ø	Rotolo	CODICE	Versione
CN022.CAVOTIR610	6	100 Mt.	CN022.CA05020601	Capocorda f.z. Ø 6
CN022.CAVOTIR625	6	250 Mt.	CN022.CA05020602	Occhiello ovale per capocorda Ø 6
CN022.CAVOTIR630	6	300 Mt.	CN022.CA05020603	Chiodo f.z. capocorda Ø 6-8
CN022.CAVOTIR810	8	100 Mt.	CN022.CA05020801	Capocorda f.z. Ø 8
CN022.CAVOTIR825	8	300 Mt.	CN022.CA05020802	Occhiello ovale per capocorda Ø 8
CN022.CAVOTIR830	8	600 Mt.		



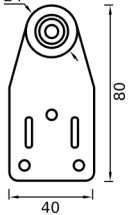

CAVO TIR ACCIAIO CON CAPOCORDA

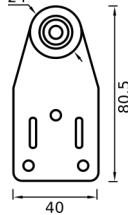

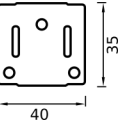

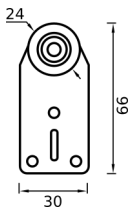
CODICE	Ø	Versione	CODICE	Ø	Versione
CN022.1105062020	6	20,2 Mt.	CN022.1105082020	8	20,2 Mt.
CN022.1105062100	6	21 Mt.	CN022.1105082220	8	22,2 Mt.
CN022.1105062200	6	22 Mt.	CN022.1105083300	8	33 Mt.
CN022.1105063300	6	33 Mt.	CN022.1105083320	8	33,2 Mt.
CN022.1105063400	6	34 Mt.	CN022.1105083400	8	34 Mt.
CN022.1105063600	6	36 Mt.	CN022.1105083420	8	34,2 Mt.
CN022.1105063800	6	38 Mt.	CN022.1105083520	8	35 Mt.
CN022.1105064600	6	46 Mt.			

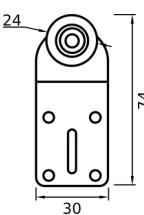

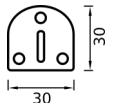

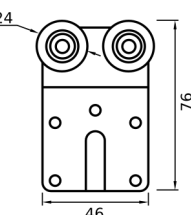

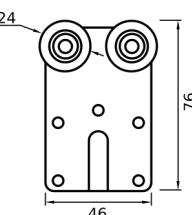

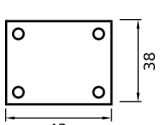
CARRUCOLE

1 CUSCINETTO - PIASTRA GRANDE			2 CUSCINETTI - PIASTRA GRANDE			CONTROPIASTRA	
							
CODICE	Versione	Ø	CODICE	Versione	Ø	CODICE	Versione
CN022.CA25012400	ZINCATA	24	CN022.CA25022400	ZINCATA	24	CN022.CA25100200	ZINCATA

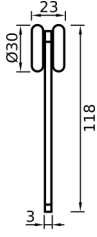
2 CUSCINETTI - PIASTRA PICCOLA			2 CUSCINETTI - PIASTRA PIEGATA			CONTROPIASTRA	
							
CODICE	Versione	Ø	CODICE	Versione	Ø	CODICE	Versione
CN022.CA25022402	ZINCATA	24	CN022.CA25022403	ZINCATA	24	CN022.CA25100202	ZINCATA

4 CUSCINETTI - PIASTRA PIEGATA			4 CUSCINETTI - PIASTRA DRITTA			CONTROPIASTRA	
							
CODICE	Versione	Ø	CODICE	Versione	Ø	CODICE	Versione
CN022.CA25042402	ZINCATA	24	CN022.CA25042400	ZINCATA	24	CN022.CA25100401	ZINCATA

CARRUCOLA BEST STAR		
		
CODICE	Versione	Ø
CN022.CA50202530	TEFLON	31

CARRUCOLA ALU STAR		
		
CODICE	Versione	Ø
CN022.CA50203530	ACCIAIO	24

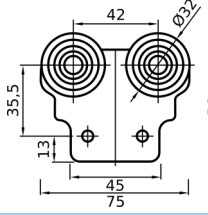
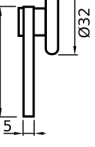
CARRUCOLA 2 FORI		
		
CODICE	Versione	Ø
CN022.VE11090130	NYLON	32

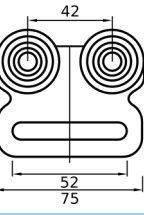
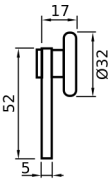
CARRUCOLA CON ASOLA		
		
CODICE	Versione	Ø
CN022.EDSPRT0028	NYLON	32



CUSCINETTI

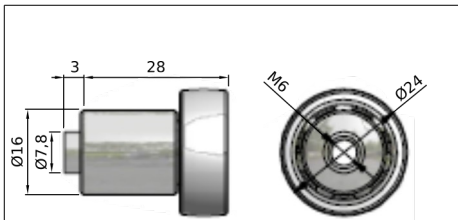

CODICE Ø

CN022.10990000411 24

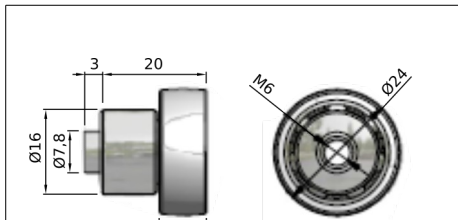

CODICE Ø

CN022.10990000410 24

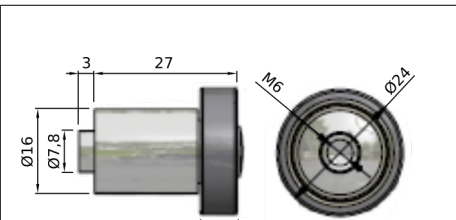

CODICE Ø

CN022.18688510000 24

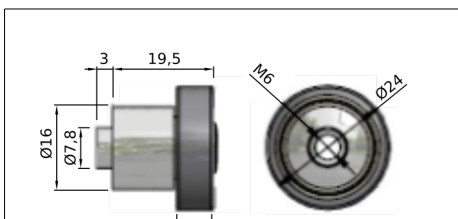

CODICE Ø

CN022.1868LAT0000 24

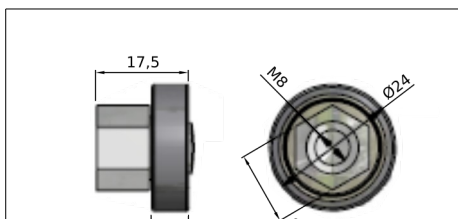

CODICE Ø

CN022.1878VERT000 24

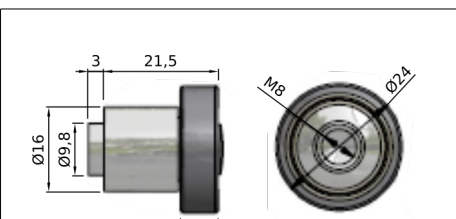

CODICE Ø

CN020.1878ORIZ000 24

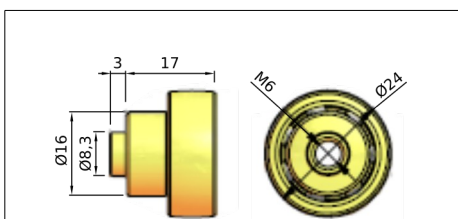

CODICE Ø

CN022.KOE13203006 24

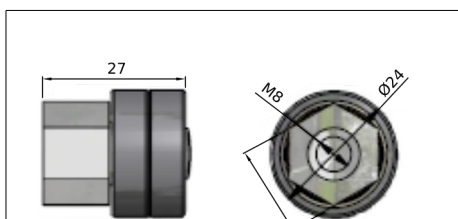

CODICE Ø

CN022.10418710000 24

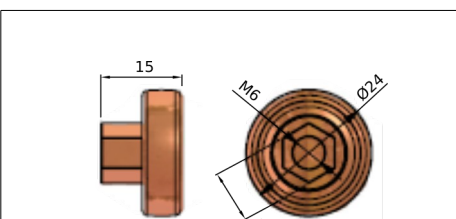

CODICE Ø

CN022.11070000178 24

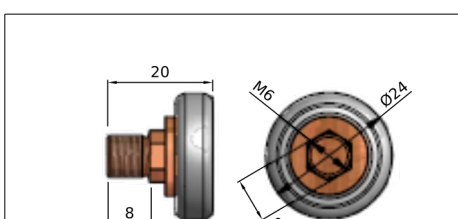

CODICE Ø

CN022.11070000154 24

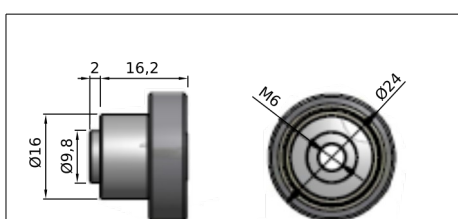

CODICE Ø

CN022.11070000182 24

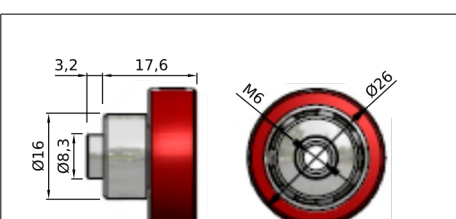

CODICE Ø

CN022.11070000020 26

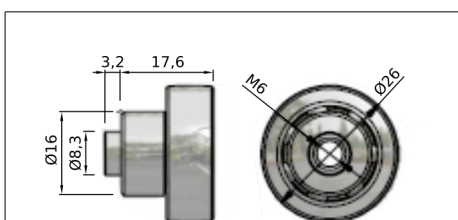

CODICE Ø

CN022.11070000044 26

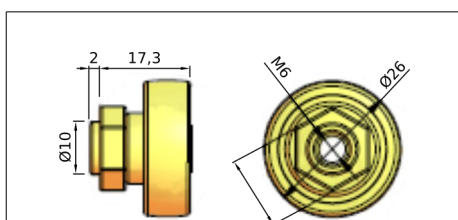

CODICE Ø

CN022.11070000184 26

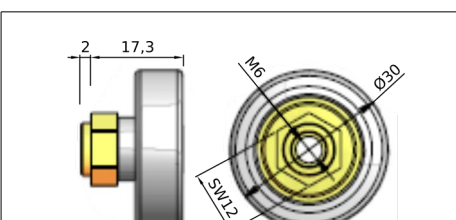

CODICE Ø

CN022.11070000166 30



TENDITELO

TENDITELO A VITE

VERSIONE DX

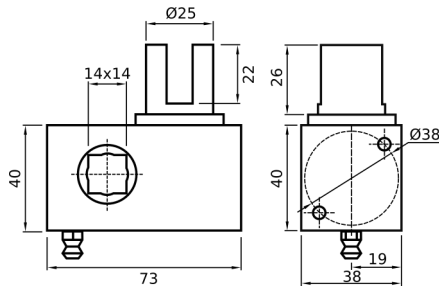
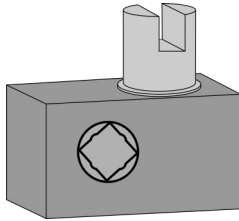

CODICE	Versione
CN022.TEND0002DX	ZINCATA (DX)
CN022.TEND0002SX	ZINCATA (SX)

TENDITELO A VITE

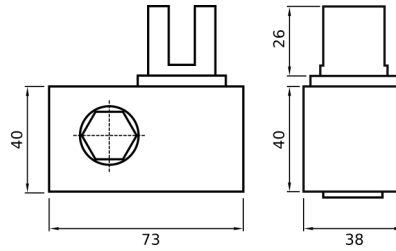
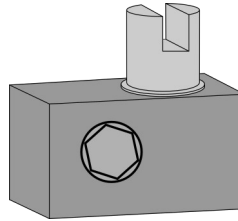

CODICE	Versione
CN022.TEND000100	ZINCATA

TENDITELO A VITE

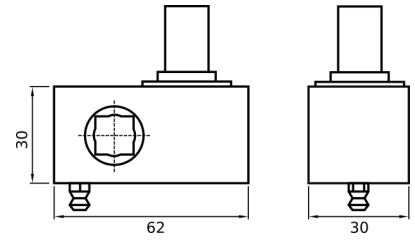
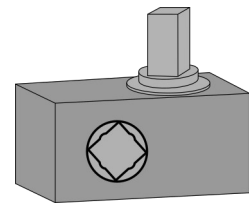

CODICE	Versione
CN022.TEND000300	ZINCATA

MANIGLIA TENDITELO



CODICE	Versione
CN022.TEND000200	ZINCATA

MANIGLIA TENDITELO

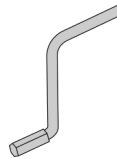

CODICE	Versione
CN022.TEND00101	ZINCATA

MANIGLIA TENDITELO



CODICE	Versione
CN022.TEND000200	ZINCATA

TENDITORE CON PERNO QUADRO

VERSIONE DX

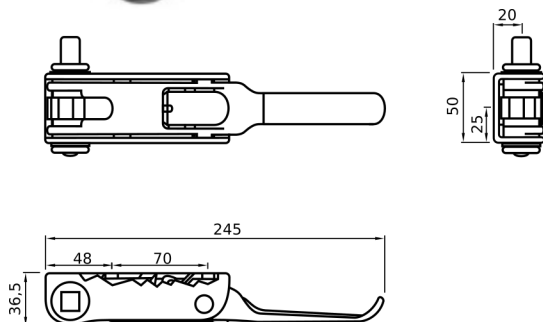

CODICE	Versione
CN022.17832500401	DX
CN022.17832500400	SX

TENDITORE CON PERNO TONDO

VERSIONE DX

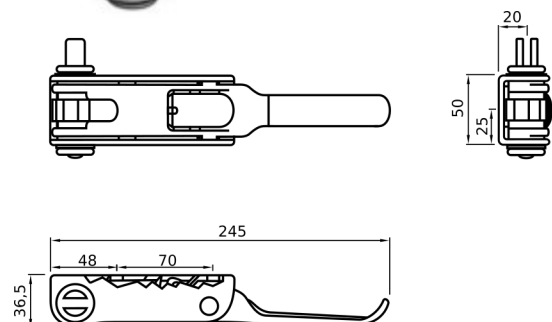

CODICE	Versione
CN022.17832500501	DX
CN022.17832500500	SX



PROFILI TENSIONE TELO

BARRA TENDITRICE Ø 27

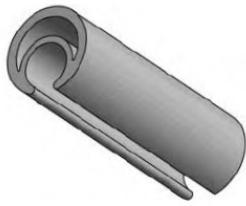

CODICE	Versione
CN032.ART1812270	ALLUMINIO (LUNGHEZZA 3 MT)

PERNO SUPERIORE



CODICE	Versione
CN022.18092000101	FERRO (per barra Ø 27)

PERNO INFERIORE

perno quadro

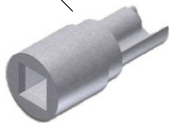

perno tondo

CODICE	Tipologia	Versione
CN022.18092000111B	perno quadro	INOX (per barra Ø 27)
CN022.18090352701	perno tondo	INOX (per barra Ø 27)

PERNO INFERIORE



CODICE	Versione
CN022.18092000120	INOX (per barra Ø 27)

PROFILO TENSIONE TELO

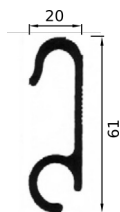

CODICE	Versione
CN032.ART1065300	ALLUMINIO (LUNGHEZZA 3 MT)

BARRA TENDITRICE Ø 35

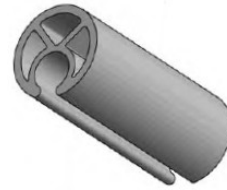

CODICE	Versione
CN032.ART2201200	ALLUMINIO (LUNGHEZZA 3 MT)

PERNO SUPERIORE



CODICE	Versione
CN022.18093371101	FERRO (per barra Ø 35)

PERNO INFERIORE



CODICE	Versione
CN022.18093371001	FERRO (per barra Ø 35)

PERNO INFERIORE



CODICE	Versione
CN022.18093371020	INOX (per barra Ø 35)

PROFILO TENSIONE TELO



CODICE	Versione
CN032.ART1387000	ALLUMINIO (LUNGHEZZA 3 MT)



PROFILI IN PVC

PROFILO IN PVC

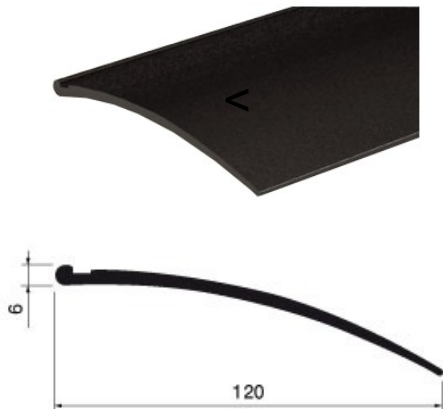

CODICE	Versione
CN022.GUAINA194M	Rotolo da 28 MT.

PROFILO IN PVC

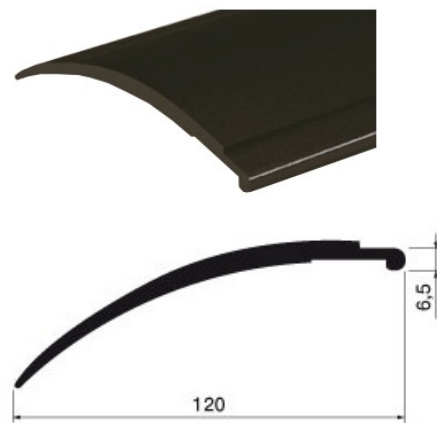

CODICE	Versione
CN022.GUAINA209M	Rotolo da 28 MT.

PROFILO IN PVC



CODICE	Versione
CN022.GUAINA289M	Rotolo da 14 MT.

PROFILO IN PVC

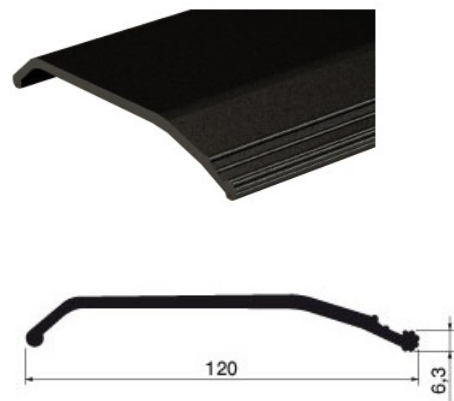

CODICE	Versione
CN022.GUAINA233M	Rotolo da 28 MT.

PROFILO IN PVC



CODICE	Versione
CN022.GUAINA331M	Rotolo da 14 MT.



ACCESSORI TELONE

PRONTOCAR A MOLLA GANCIO CHUSO



CODICE	Versione
CN022.PR50031752	Cricchetto inox / Gancio ferro

PRONTOCAR A MOLLA GANCIO APERTO



CODICE	Versione
CN022.PR50031753	Cricchetto inox / Gancio inox

PIASTRA DI FISSAGGIO PRONTOCAR



CODICE	Versione	H
CN022.PR50121760	INOX	12

PIASTRA DI FISSAGGIO PRONTOCAR



CODICE	Versione	H
CN022.PR50121759	INOX	18

PIASTRA PIEGHEVOLE SESAM



CODICE	Lunghezza	Versione
CN022.SE19425870	692 mm	INCASTRO
CN022.SE19425860	592 mm	INCASTRO
CN022.SE19425850	492 mm	INCASTRO
CN022.SE19425840	392 mm	INCASTRO

PIASTRA PIEGHEVOLE VERSUS



CODICE	Lunghezza	Versione
CN022.VE11070700	700 mm	INCASTRO
CN022.VE11070600	600 mm	INCASTRO
CN022.VE11070500	500 mm	INCASTRO
CN022.VE11070400	400 mm	INCASTRO

PIASTRA PIEGHEVOLE EDSCHA

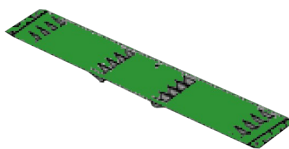

CODICE	Lunghezza	Versione
CN022.ED38034110	650 mm	RIVETTARE
CN022.ED38034210	570 mm	RIVETTARE

PIASTRA PIEGHEVOLE EDSCHA

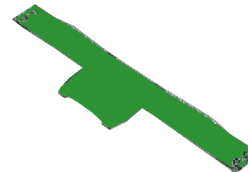

CODICE	Lunghezza	Versione
CN022.ED38074610	650 mm	INCASTRO

ROLLER PER PIATTO EDSCHA



CODICE	Versione
CN022.ED38077260	FERRO

PISTONCINI A GAS

CODICE	Versione
CN022.VE11070046	700 N

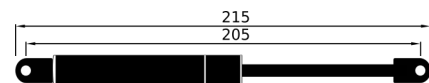

CODICE	Versione
CN022.SE17996000	600 N

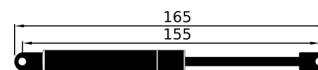

CODICE	Versione
CN022.SE17990000	400 N

